

TECHNICAL DATA SHEET

VALSIR® FLUSHING SYSTEMS

PUSH PLATES



valsir®
QUALITY FOR PLUMBING

P1

Characteristics

Raw material:	ABS
Compatible cisterns:	Tropea S, Cubik S, Winner S

Code	Actuators	Finishes
VS0871301	Mechanic	White
VS0871335	Mechanic	Polished chrome
VS0871337	Mechanic	Satin chrome
VS0872601	Pneumatic	White
VS0872635	Pneumatic	Polished chrome
VS0872637	Pneumatic	Satin chrome

Push plates:

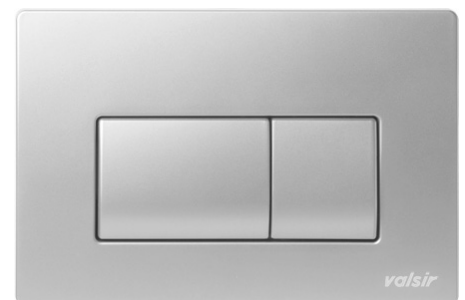
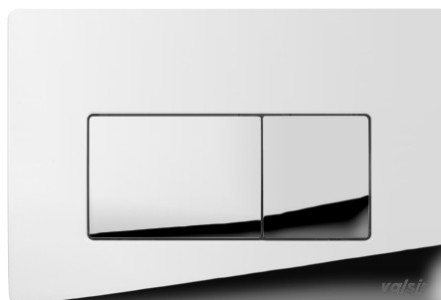
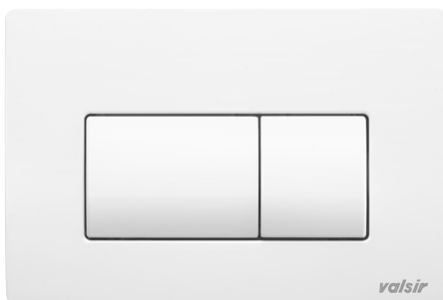

Technical specs:

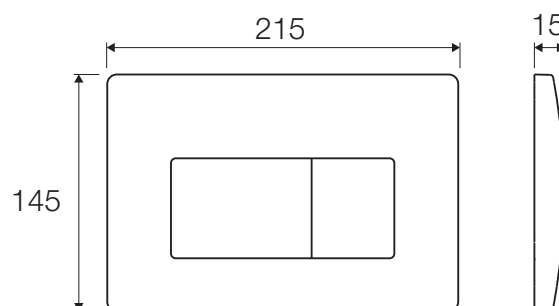

P2

Characteristics

Raw material:	ABS
Compatible cisterns:	Tropea S, Cubik S, Winner S

Code	Actuators	Finishes
VS0872801	Mechanic	White
VS0872835	Mechanic	Polished chrome
VS0872837	Mechanic	Satin chrome
VS0871501	Pneumatic	White
VS0871535	Pneumatic	Polished chrome
VS0871537	Pneumatic	Satin chrome

Push plates:

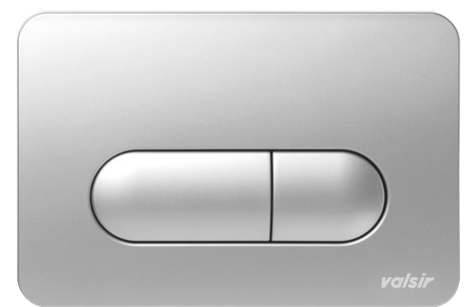
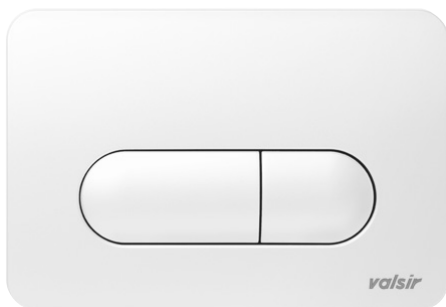

Technical specs:

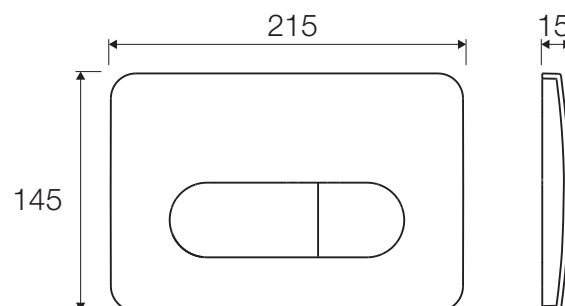

P3

Characteristics

Raw material: ABS

Compatible cisterns: Tropea S, Cubik S, Winner S

Code	Actuators	Finishes
VS0869201	Mechanic	White
VS0869235	Mechanic	Polished chrome
VS0869237	Mechanic	Satin chrome
VS0869211	Pneumatic	White
VS0869245	Pneumatic	Polished chrome
VS0869247	Pneumatic	Satin chrome

Push plates:

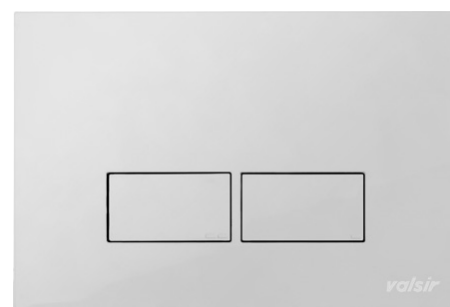
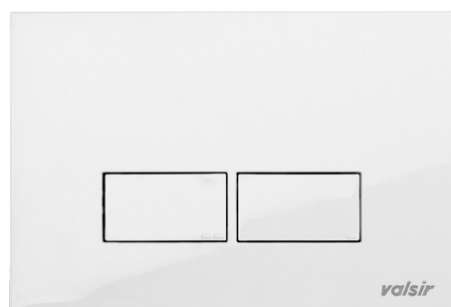

Technical specs:

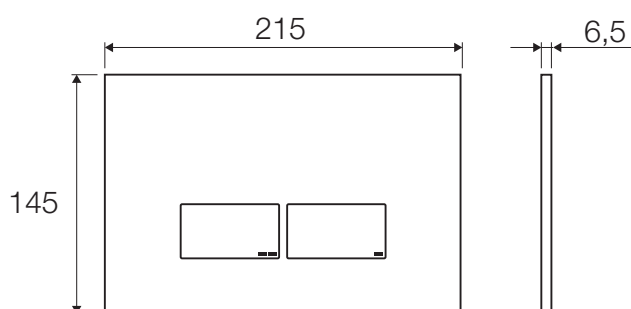

P4

Characteristics

Raw material:	ABS
Compatible cisterns:	Tropea S, Cubik S, Winner S

Code	Actuators	Finishes
VS0869301	Mechanic	White
VS0869335	Mechanic	Polished chrome
VS0869337	Mechanic	Satin chrome
VS0869311	Pneumatic	White
VS0869345	Pneumatic	Polished chrome
VS0869347	Pneumatic	Satin chrome

Push plates:

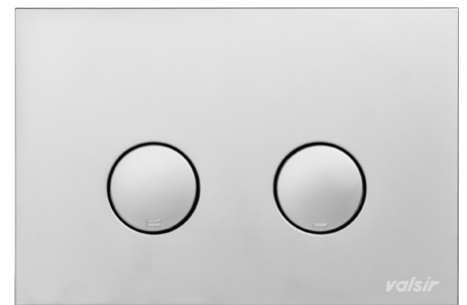
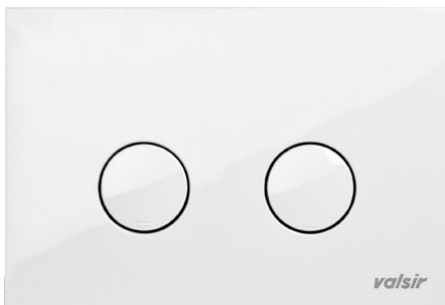

Technical specs:

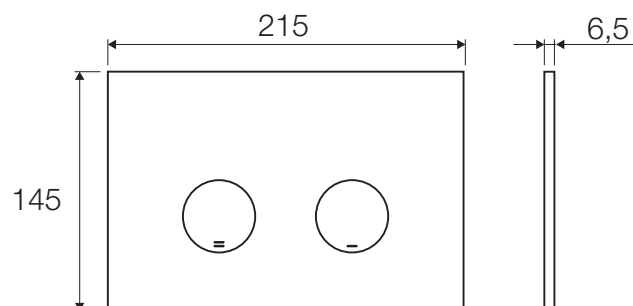

P5

Characteristics

Raw material:	ABS
Compatible cisterns:	Tropea S, Cubik S, Winner S

Code	Actuators	Finishes
VS0869401	Mechanic	White
VS0869402	Mechanic	White / Polished chrome
VS0869435	Mechanic	Polished chrome
VS0869437	Mechanic	Satin chrome
VS0869404	Mechanic	White / Gold
VS0869411	Pneumatic	White
VS0869412	Pneumatic	White / Polished chrome
VS0869445	Pneumatic	Polished chrome
VS0869447	Pneumatic	Satin chrome
VS0869414	Pneumatic	White / Gold

Push plates:



Technical specs:

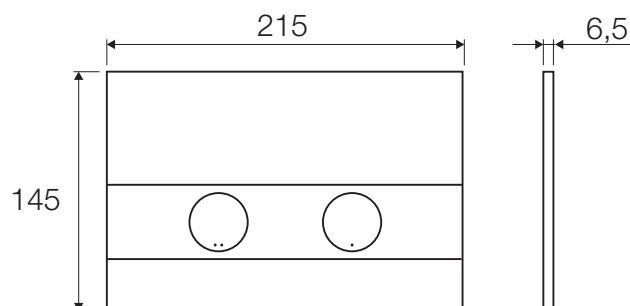

P6

Characteristics

Raw material:	Metal
Compatible cisterns:	Tropea S, Cubik S, Winner S
Security:	Anti vandalism push plate

Code	Actuators	Finishes
VS0870235	Mechanic	Polished chrome
VS0870237	Mechanic	Satin chrome

Push plates:

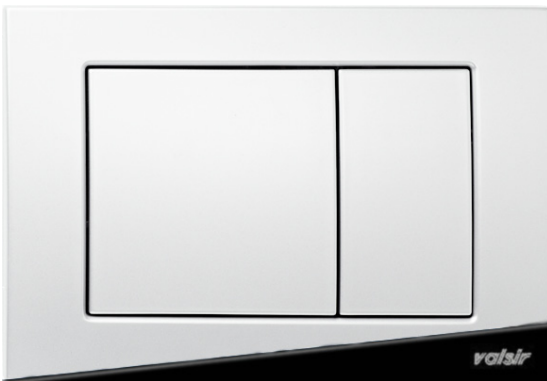

Technical specs:

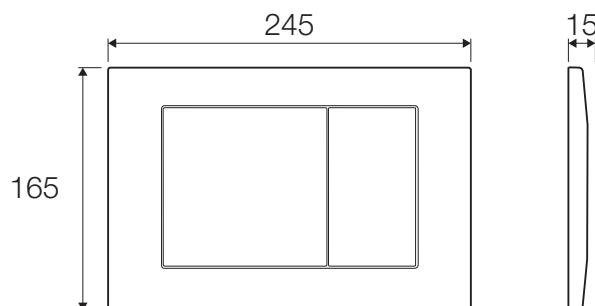

P7

Characteristics

Raw material: Stainless Steel

Compatible cisterns: Tropea S, Cubik S, Winner S

Code	Actuators	Finishes
VS0871735	Pneumatic	Polished Stainless steel
VS0871737	Pneumatic	Satin Stainless steel

Push plates:



Technical specs:

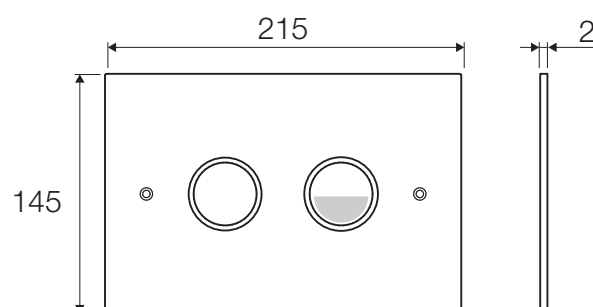

Infrarossa Dual

Characteristics

Raw material:	Metal
Compatible cisterns:	Tropea S, Cubik S, Winner S
Flush:	Single

Code	Actuators	Finishes
VS0868901	Electronic / Manual	Polished chrome

Push plates:



Technical specs:

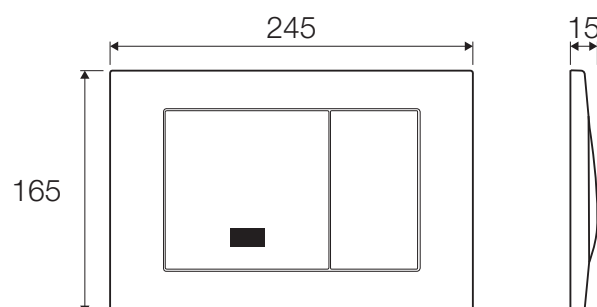

Infrarossa Eye

Characteristics

Raw material:	Metal
Compatible cisterns:	Tropea S, Cubik S, Winner S
Flush:	Single

Code	Actuators	Finishes
VS0868911	Electronic	Polished chrome

Push plates:



Technical specs:

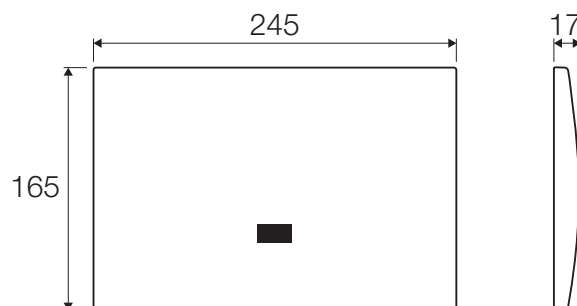

Infrarossa Inox

Characteristics

Raw material: Stainless Steel

Compatible cisterns: Tropea S, Cubik S, Winner S

Flush: Single

Code

Actuators

Finishes

VS0868915

Electronic

Stainless Steel

Push plates:

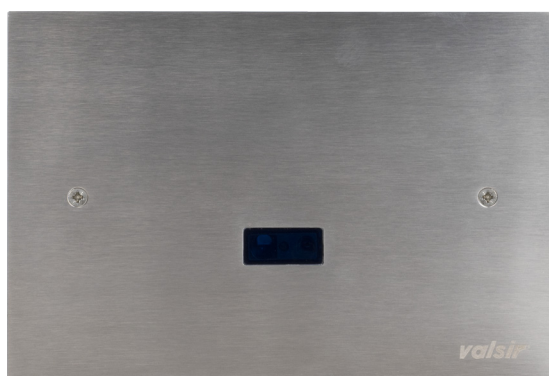

Technical specs:

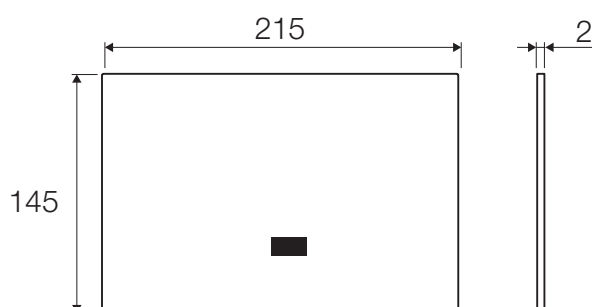

Infrarossa Remote

Characteristics

Raw material:	Metal
Compatible cisterns:	Tropea S, Cubik S, Winner S
Flush:	Single

Code	Actuators	Finishes
VS0868921	Electronic	Polished chrome

Push plates:



Technical specs:

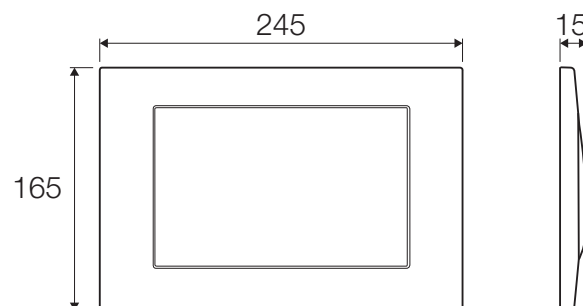

Black&White AC white

Characteristics

Raw material: DuPont™ Corian® - Glacier white

Compatible cisterns: Tropea S, Cubik S, Winner S

Actuator: Pneumatic

Code	Buttons	Buttons Finishing	Size	Code	Buttons	Buttons Finishing	Size
VS0878860	Round	Polished	Medium	VS0878862	Square	Polished	Medium
VS0878861	Round	Satin	Medium	VS0878863	Square	Satin	Medium

Push plates:

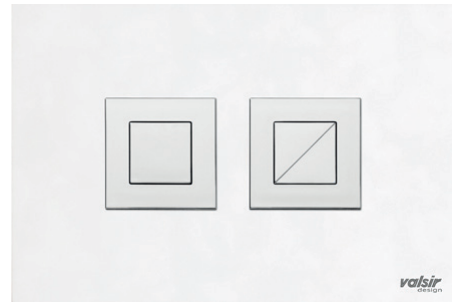

Technical specs:

MEDIUM

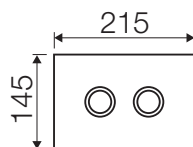

Black&White AC black

Characteristics

Raw material: DuPont™ Corian® - Nocturne

Compatible cisterns: Tropea S, Cubik S, Winner S

Actuator: Pneumatic

Code	Buttons	Buttons Finishing	Size	Code	Buttons	Buttons Finishing	Size
VS0878864	Round	Polished	Medium	VS0878866	Square	Polished	Medium
VS0878865	Round	Satin	Medium	VS0878867	Square	Satin	Medium

Push plates:

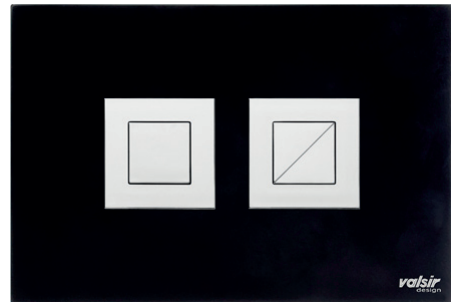

Technical specs:

MEDIUM

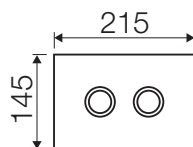

Black&White AL black

Characteristics

Raw material:	Black anodized aluminium
Compatible cisterns:	Tropea S, Cubik S, Winner S
Actuator:	Pneumatic

Code	Buttons	Buttons Finishing	Size	Code	Buttons	Buttons Finishing	Size
VS08788688	Round	Polished	Medium	VS0878870	Square	Polished	Medium
VS0878869	Round	Satin	Medium	VS0878871	Square	Satin	Medium

Push plates:

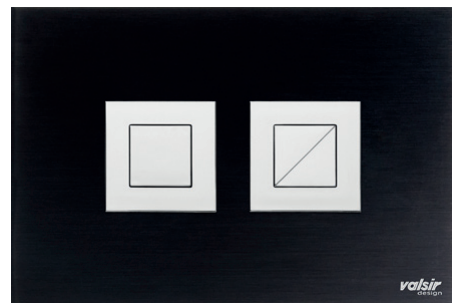

Technical specs:

MEDIUM

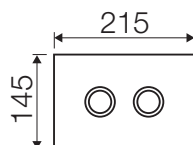

CRYSTAL Red

Characteristics

Raw material:	Glass
Compatible cisterns:	Tropea S, Cubik S, Winner S
Actuator:	Pneumatic

Code	Buttons	Buttons Finishing	Size	Code	Buttons	Buttons Finishing	Size
VS0877601	Round	Polished	Small	VS0877605	Square	Polished	Small
VS0877301	Round	Polished	Medium	VS0877305	Square	Polished	Medium
VS0877001	Round	Polished	Large	VS0877005	Square	Polished	Large
VS0877603	Round	Satin	Small	VS0877607	Square	Satin	Small
VS0877303	Round	Satin	Medium	VS0877307	Square	Satin	Medium
VS0877003	Round	Satin	Large	VS0877007	Square	Satin	Large

Push plates:

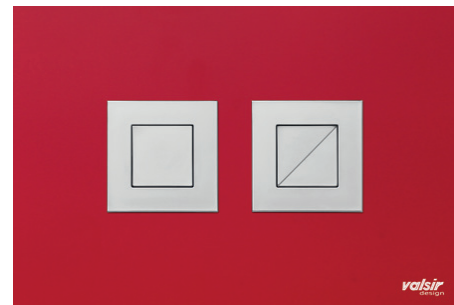

Technical specs:

SMALL

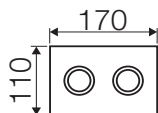

MEDIUM

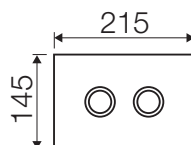

LARGE

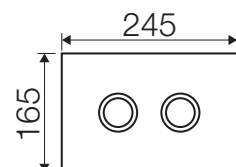

CRYSTAL Malaysia

Characteristics

Raw material:	Glass
Compatible cisterns:	Tropea S, Cubik S, Winner S
Actuator:	Pneumatic

Code	Buttons	Buttons Finishing	Size	Code	Buttons	Buttons Finishing	Size
VS0877611	Round	Polished	Small	VS0877615	Square	Polished	Small
VS0877311	Round	Polished	Medium	VS0877315	Square	Polished	Medium
VS0877011	Round	Polished	Large	VS0877015	Square	Polished	Large
VS0877613	Round	Satin	Small	VS0877617	Square	Satin	Small
VS0877313	Round	Satin	Medium	VS0877317	Square	Satin	Medium
VS0877013	Round	Satin	Large	VS0877017	Square	Satin	Large

Push plates:

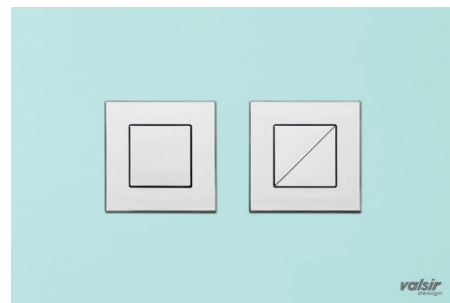

Technical specs:

SMALL

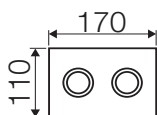

MEDIUM

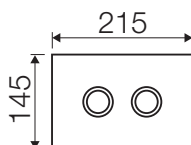

LARGE

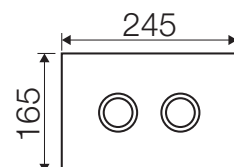

CRYSTAL Ice

Characteristics

Raw material:	Glass
Compatible cisterns:	Tropea S, Cubik S, Winner S
Actuator:	Pneumatic

Code	Buttons	Buttons Finishing	Size	Code	Buttons	Buttons Finishing	Size
VS0877621	Round	Polished	Small	VS0877625	Square	Polished	Small
VS0877321	Round	Polished	Medium	VS0877325	Square	Polished	Medium
VS0877021	Round	Polished	Large	VS0877025	Square	Polished	Large
VS0877623	Round	Satin	Small	VS0877627	Square	Satin	Small
VS0877323	Round	Satin	Medium	VS0877327	Square	Satin	Medium
VS0877023	Round	Satin	Large	VS0877027	Square	Satin	Large

Push plates:

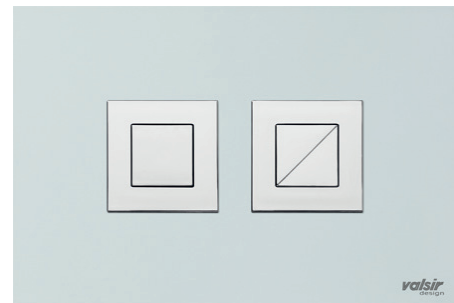

Technical specs:

SMALL

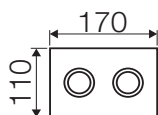

MEDIUM

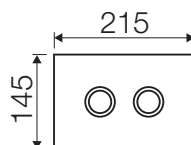

LARGE

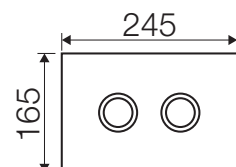

CRYSTAL Europe white

Characteristics

Raw material:	Glass
Compatible cisterns:	Tropea S, Cubik S, Winner S
Actuator:	Pneumatic

Code	Buttons	Buttons Finishing	Size	Code	Buttons	Buttons Finishing	Size
VS0877631	Round	Polished	Small	VS0877635	Square	Polished	Small
VS0877331	Round	Polished	Medium	VS0877335	Square	Polished	Medium
VS0877031	Round	Polished	Large	VS0877035	Square	Polished	Large
VS0877633	Round	Satin	Small	VS0877637	Square	Satin	Small
VS0877333	Round	Satin	Medium	VS0877337	Square	Satin	Medium
VS0877033	Round	Satin	Large	VS0877037	Square	Satin	Large

Push plates:

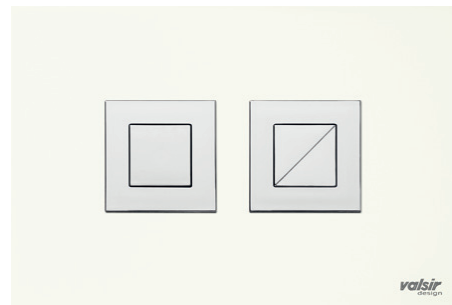
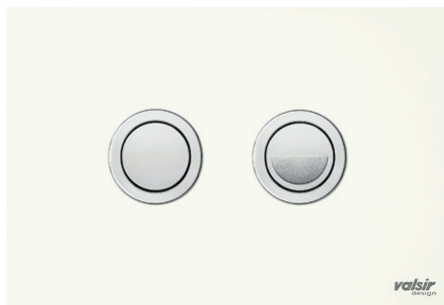

Technical specs:

SMALL

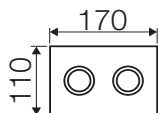

MEDIUM

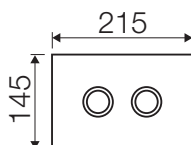

LARGE

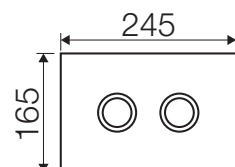

CRYSTAL RAL 9010 white

Characteristics

Raw material:	Glass
Compatible cisterns:	Tropea S, Cubik S, Winner S
Actuator:	Pneumatic

Code	Buttons	Buttons Finishing	Size	Code	Buttons	Buttons Finishing	Size
VS0877641	Round	Polished	Small	VS0877645	Square	Polished	Small
VS0877341	Round	Polished	Medium	VS0877345	Square	Polished	Medium
VS0877041	Round	Polished	Large	VS0877045	Square	Polished	Large
VS0877643	Round	Satin	Small	VS0877647	Square	Satin	Small
VS0877343	Round	Satin	Medium	VS0877347	Square	Satin	Medium
VS0877043	Round	Satin	Large	VS0877047	Square	Satin	Large

Push plates:

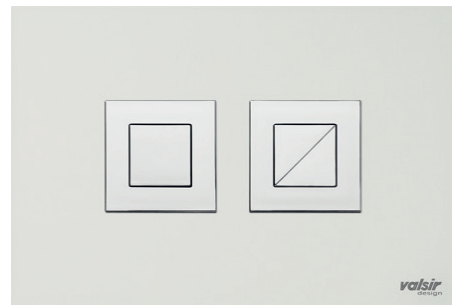

Technical specs:

SMALL

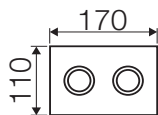

MEDIUM

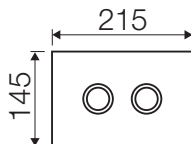

LARGE

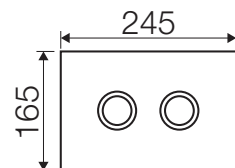

CRYSTAL Black

Characteristics

Raw material:	Glass
Compatible cisterns:	Tropea S, Cubik S, Winner S
Actuator:	Pneumatic

Code	Buttons	Buttons Finishing	Size	Code	Buttons	Buttons Finishing	Size
VS0877651	Round	Polished	Small	VS0877655	Square	Polished	Small
VS0877351	Round	Polished	Medium	VS0877355	Square	Polished	Medium
VS0877051	Round	Polished	Large	VS0877055	Square	Polished	Large
VS0877653	Round	Satin	Small	VS0877657	Square	Satin	Small
VS0877353	Round	Satin	Medium	VS0877357	Square	Satin	Medium
VS0877053	Round	Satin	Large	VS0877057	Square	Satin	Large

Push plates:

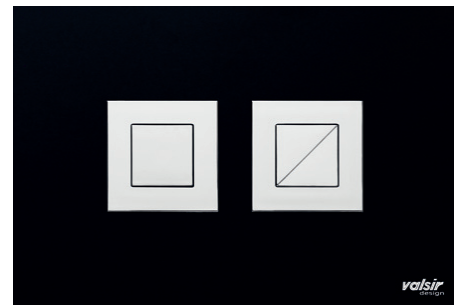

Technical specs:

SMALL

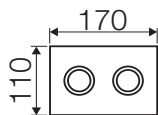

MEDIUM

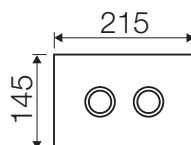

LARGE

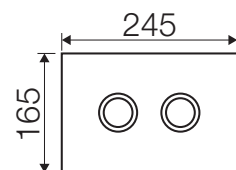

CRYSTAL Pearl grey

Characteristics

Raw material:	Glass
Compatible cisterns:	Tropea S, Cubik S, Winner S
Actuator:	Pneumatic

Code	Buttons	Buttons Finishing	Size
VS0877361	Round	Polished	Medium
VS0877363	Round	Satin	Medium
VS0877365	Square	Polished	Medium
VS0877367	Square	Satin	Medium

Push plates:

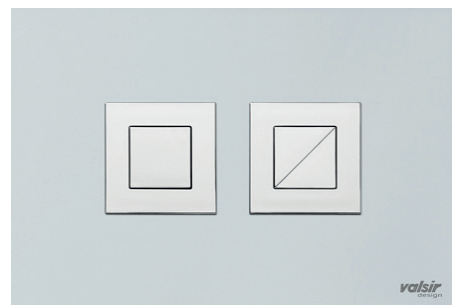

Technical specs:

MEDIUM

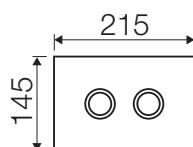

CRYSTAL Satin Europe white

Characteristics

Raw material:	Glass
Compatible cisterns:	Tropea S, Cubik S, Winner S
Actuator:	Pneumatic

Code	Buttons	Buttons Finishing	Size
VS0877332	Round	Polished	Medium
VS0877334	Round	Satin	Medium
VS0877336	Square	Polished	Medium
VS0877338	Square	Satin	Medium

Push plates:

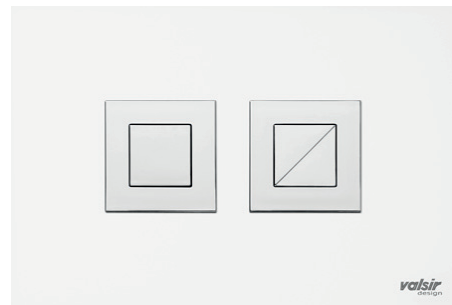

Technical specs:

MEDIUM

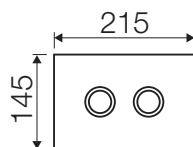

CRYSTAL Satin RAL 9010 white

Characteristics

Raw material:	Glass
Compatible cisterns:	Tropea S, Cubik S, Winner S
Actuator:	Pneumatic

Code	Buttons	Buttons Finishing	Size
VS0877342	Round	Polished	Medium
VS0877344	Round	Satin	Medium
VS0877346	Square	Polished	Medium
VS0877348	Square	Satin	Medium

Push plates:

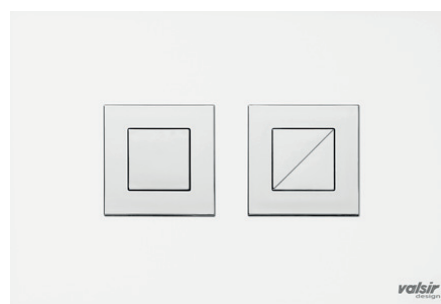

Technical specs:

MEDIUM

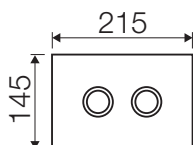

CRYSTAL Satin black

Characteristics

Raw material:	Glass
Compatible cisterns:	Tropea S, Cubik S, Winner S
Actuator:	Pneumatic

Code	Buttons	Buttons Finishing	Size
VS0877352	Round	Polished	Medium
VS0877354	Round	Satin	Medium
VS0877356	Square	Polished	Medium
VS0877358	Square	Satin	Medium

Push plates:

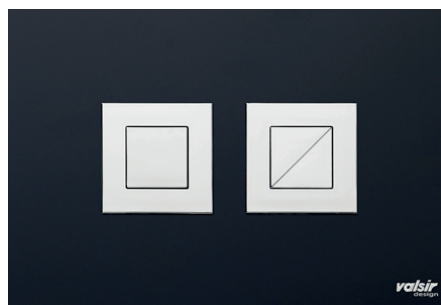

Technical specs:

MEDIUM

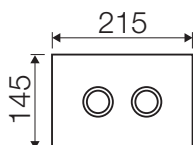

CRYSTAL Satin pearl grey

Characteristics

Raw material:	Glass
Compatible cisterns:	Tropea S, Cubik S, Winner S
Actuator:	Pneumatic

Code	Buttons	Buttons Finishing	Size
VS0877362	Round	Polished	Medium
VS0877364	Round	Satin	Medium
VS0877366	Square	Polished	Medium
VS0877368	Square	Satin	Medium

Push plates:

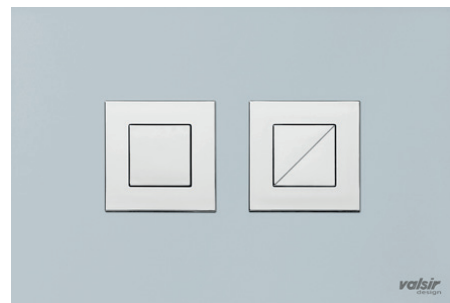

Technical specs:

MEDIUM

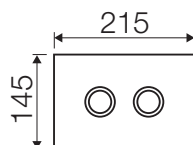

Inox Polished chrome

Characteristics

Raw material:	Stainless Steel
Compatible cisterns:	Tropea S, Cubik S, Winner S
Actuator:	Pneumatic

Code	Buttons	Buttons Finishing	Size
VS0877961	Round	Polished	Small
VS0877931	Round	Polished	Medium
VS0877901	Round	Polished	Large
VS0877965	Square	Polished	Small
VS0877935	Square	Polished	Medium
VS0877905	Square	Polished	Large

Push plates:

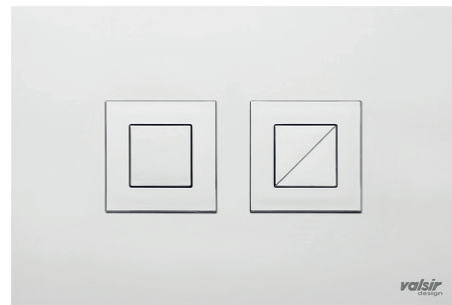

Technical specs:

SMALL

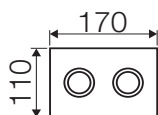

MEDIUM

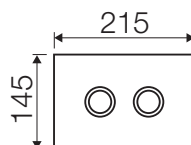

LARGE

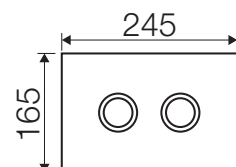

Inox Satin chrome

Characteristics

Raw material:	Stainless Steel
Compatible cisterns:	Tropea S, Cubik S, Winner S
Actuator:	Pneumatic

Code	Buttons	Buttons Finishing	Size
VS0877963	Round	Satin	Small
VS0877933	Round	Satin	Medium
VS0877903	Round	Satin	Large
VS0877967	Square	Satin	Small
VS0877937	Square	Satin	Medium
VS0877907	Square	Satin	Large

Push plates:

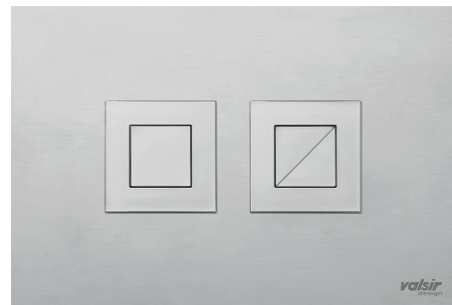

Technical specs:

SMALL

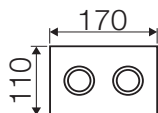

MEDIUM

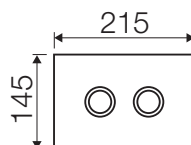

LARGE

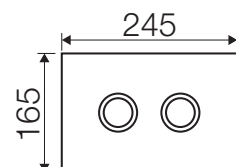

Wood Zebrano

Characteristics

Raw material:	Wood
Compatible cisterns:	Tropea S, Cubik S, Winner S
Actuator:	Pneumatic

Code	Buttons	Buttons Finishing	Size
VS0876301	Round	Polished	Medium
VS0876001	Round	Polished	Large
VS0876303	Round	Satin	Medium
VS0876003	Round	Satin	Large
VS0876305	Square	Polished	Medium
VS0876005	Square	Polished	Large
VS0876307	Square	Satin	Medium
VS0876007	Square	Satin	Large

Push plates:

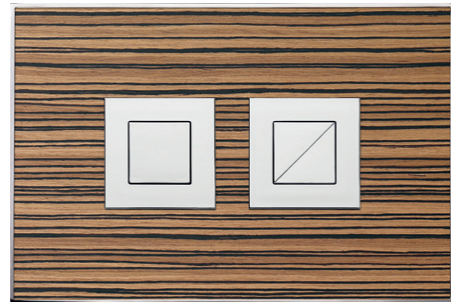

Technical specs:

MEDIUM

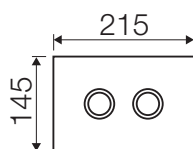

LARGE

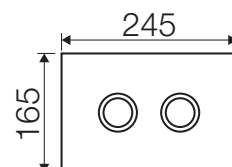

Wood Blanc oak

Characteristics

Raw material:	Wood
Compatible cisterns:	Tropea S, Cubik S, Winner S
Actuator:	Pneumatic

Code	Buttons	Buttons Finishing	Size
VS0876331	Round	Polished	Medium
VS0876031	Round	Polished	Large
VS0876333	Round	Satin	Medium
VS0876033	Round	Satin	Large
VS0876335	Square	Polished	Medium
VS0876035	Square	Polished	Large
VS0876337	Square	Satin	Medium
VS0876037	Square	Satin	Large

Push plates:

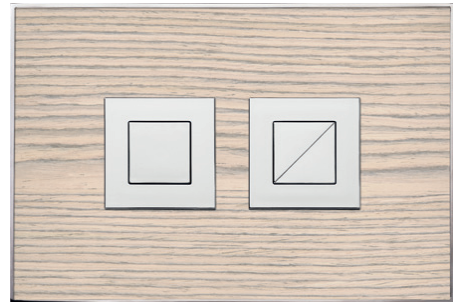

Technical specs:

MEDIUM

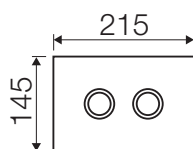

LARGE

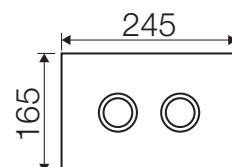

Wood Wengè

Characteristics

Raw material:	Wood
Compatible cisterns:	Tropea S, Cubik S, Winner S
Actuator:	Pneumatic

Code	Buttons	Finishing Buttons	Size
VS0876351	Round	Polished	Medium
VS0876051	Round	Polished	Large
VS0876353	Round	Satin	Medium
VS0876053	Round	Satin	Large
VS0876355	Square	Polished	Medium
VS0876055	Square	Polished	Large
VS0876357	Square	Satin	Medium
VS0876057	Square	Satin	Large

Push plates:

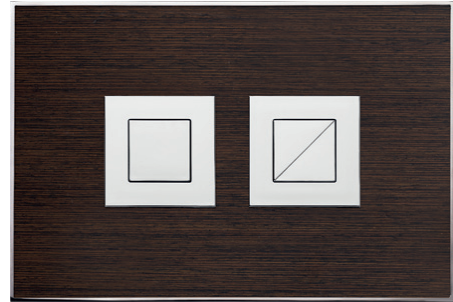

Technical specs:

MEDIUM

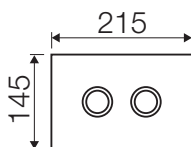

LARGE

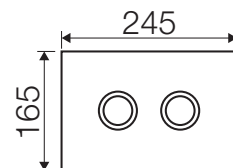

Wood Malindi ebony

Characteristics

Raw material:	Wood
Compatible cisterns:	Tropea S, Cubik S, Winner S
Actuator:	Pneumatic

Code	Buttons	Buttons Finishing	Size
VS0876311	Round	Polished	Medium
VS0876011	Round	Polished	Large
VS0876313	Round	Satin	Medium
VS0876013	Round	Satin	Large
VS0876315	Square	Polished	Medium
VS0876015	Square	Polished	Large
VS0876317	Square	Satin	Medium
VS0876017	Square	Satin	Large

Push plates:

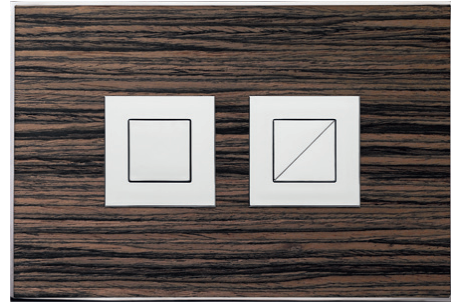

Technical specs:

MEDIUM

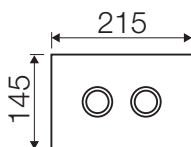

LARGE

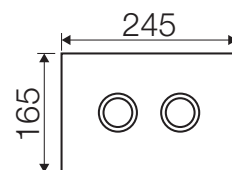

Wood Grey oak

Characteristics

Raw material:	Wood
Compatible cisterns:	Tropea S, Cubik S, Winner S
Actuator:	Pneumatic

Code	Buttons	Buttons Finishing	Size
VS0876341	Round	Polished	Medium
VS0876041	Round	Polished	Large
VS0876343	Round	Satin	Medium
VS0876043	Round	Satin	Large
VS0876345	Square	Polished	Medium
VS0876045	Square	Polished	Large
VS0876347	Square	Satin	Medium
VS0876047	Square	Satin	Large

Push plates:

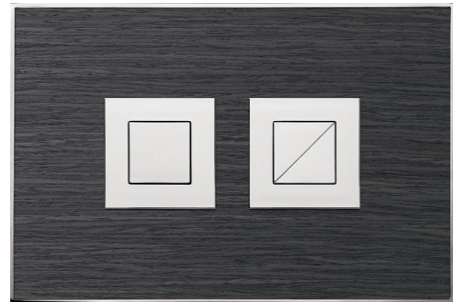

Technical specs:

MEDIUM

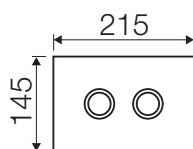

LARGE

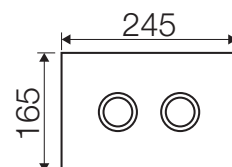

Wood Makassar ebony

Characteristics

Raw material:	Wood
Compatible cisterns:	Tropea S, Cubik S, Winner S
Actuator:	Pneumatic

Code	Buttons	Buttons Finishing	Size
VS0876321	Round	Polished	Medium
VS0876021	Round	Polished	Large
VS0876323	Round	Satin	Medium
VS0876023	Round	Satin	Large
VS0876325	Square	Polished	Medium
VS0876025	Square	Polished	Large
VS0876327	Square	Satin	Medium
VS0876027	Square	Satin	Large

Push plates:

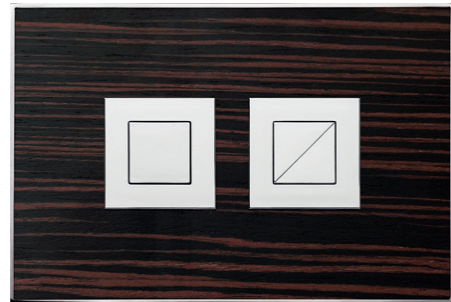

Technical specs:

MEDIUM

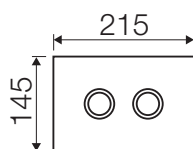

LARGE

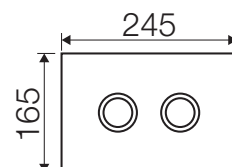

Stone Anthracite

Characteristics

Raw material:	Stone
Compatible cisterns:	Tropea S, Cubik S, Winner S
Actuator:	Pneumatic

Code	Buttons	Buttons Finishing	Size
VS0876801	Round	Polished	Medium
VS0876601	Round	Polished	Large
VS0876803	Round	Satin	Medium
VS0876603	Round	Satin	Large
VS0876805	Square	Polished	Medium
VS0876605	Square	Polished	Large
VS0876807	Square	Satin	Medium
VS0876607	Square	Satin	Large

Push plates:

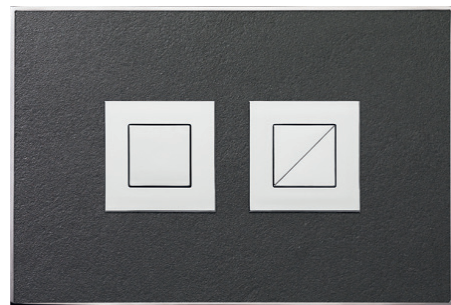

Technical specs:

MEDIUM

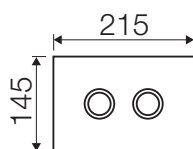

LARGE

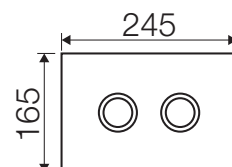

Stone Slate

Characteristics

Raw material:	Stone
Compatible cisterns:	Tropea S, Cubik S, Winner S
Actuator:	Pneumatic

Code	Buttons	Buttons Finishing	Size
VS0876811	Round	Polished	Medium
VS0876611	Round	Polished	Large
VS0876813	Round	Satin	Medium
VS0876613	Round	Satin	Large
VS0876815	Square	Polished	Medium
VS0876615	Square	Polished	Large
VS0876817	Square	Satin	Medium
VS0876617	Square	Satin	Large

Push plates:

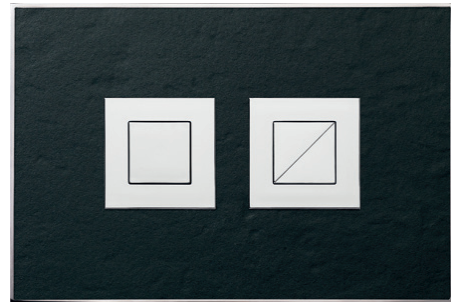

Technical specs:

MEDIUM

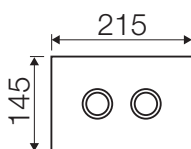

LARGE

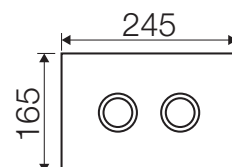

Stone Brown

Characteristics

Raw material:	Gres
Compatible cisterns:	Tropea S, Cubik S, Winner S
Actuator:	Pneumatic

Code	Buttons	Buttons Finishing	Size
VS0876821	Round	Polished	Medium
VS0876621	Round	Polished	Large
VS0876823	Round	Satin	Medium
VS0876623	Round	Satin	Large
VS0876825	Square	Polished	Medium
VS0876625	Square	Polished	Large
VS0876827	Square	Satin	Medium
VS0876627	Square	Satin	Large

Push plates:

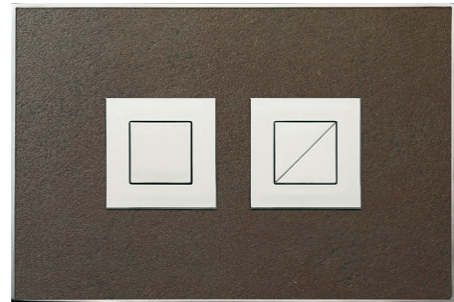

Technical specs:

MEDIUM

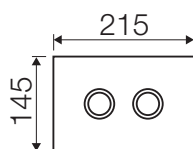

LARGE

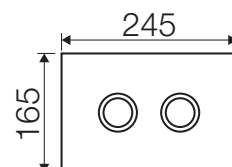

Stone Jerusalem stone

Characteristics

Raw material:	Stone
Compatible cisterns:	Tropea S, Cubik S, Winner S
Actuator:	Pneumatic

Code	Buttons	Buttons Finishing	Size
VS0876831	Round	Polished	Medium
VS0876631	Round	Polished	Large
VS0876833	Round	Satin	Medium
VS0876633	Round	Satin	Large
VS0876835	Square	Polished	Medium
VS0876635	Square	Polished	Large
VS0876837	Square	Satin	Medium
VS0876637	Square	Satin	Large

Push plates:

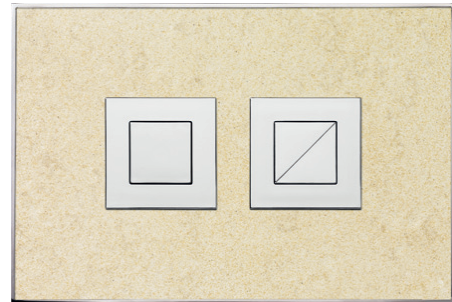

Technical specs:

MEDIUM

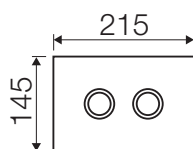

LARGE

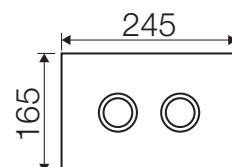

Fantasy White drapery

Characteristics

Raw material:	Acrylic
Compatible cisterns:	Tropea S, Cubik S, Winner S
Actuator:	Pneumatic

Code	Buttons	Buttons Finishing	Size
VS0878801	Round	Polished	Medium
VS0878601	Round	Polished	Large
VS0878803	Round	Satin	Medium
VS0878603	Round	Satin	Large
VS0878805	Square	Polished	Medium
VS0878605	Square	Polished	Large
VS0878807	Square	Satin	Medium
VS0878607	Square	Satin	Large

Push plates:

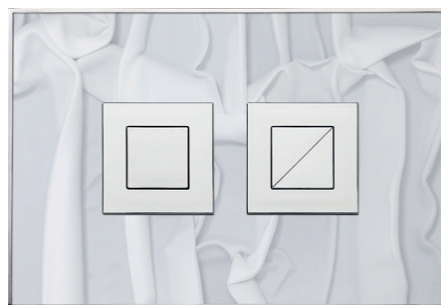

Technical specs:

MEDIUM

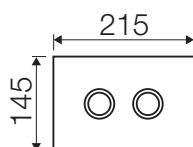

LARGE

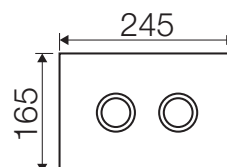

Fantasy Black drapery

Characteristics

Raw material:	Acrylic
Compatible cisterns:	Tropea S, Cubik S, Winner S
Actuator:	Pneumatic

Code	Buttons	Buttons Finishing	Size
VS0878811	Round	Polished	Medium
VS0878813	Round	Satin	Medium
VS0878815	Square	Polished	Medium
VS0878817	Square	Satin	Medium

Push plates:

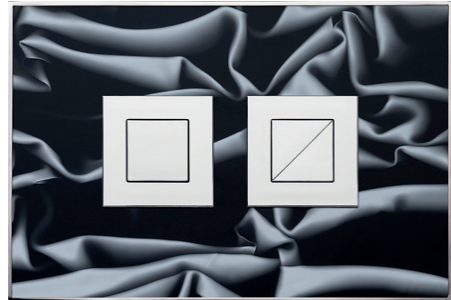
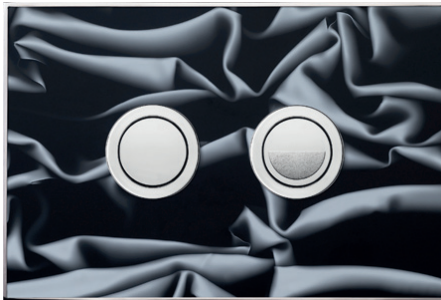

Technical specs:

MEDIUM

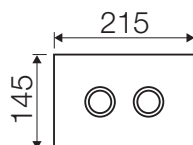

Fantasy Caramel drapery

Characteristics

Raw material:	Acrylic
Compatible cisterns:	Tropea S, Cubik S, Winner S
Actuator:	Pneumatic

Code	Buttons	Buttons Finishing	Size
VS0878821	Round	Polished	Medium
VS0878621	Round	Polished	Large
VS0878823	Round	Satin	Medium
VS0878623	Round	Satin	Large
VS0878825	Square	Polished	Medium
VS0878625	Square	Polished	Large
VS0878827	Square	Satin	Medium
VS0878627	Square	Satin	Large

Push plates:

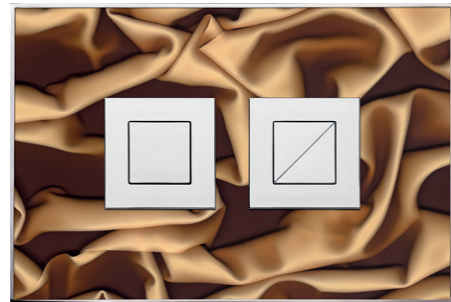

Technical specs:

MEDIUM

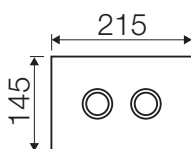

LARGE

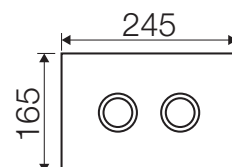

Fantasy Roses

Characteristics

Raw material:	Multilayer glass
Compatible cisterns:	Tropea S, Cubik S, Winner S
Actuator:	Pneumatic

Code	Buttons	Buttons Finishing	Size
VS0878311	Round	Polished	Medium
VS0878011	Round	Polished	Large
VS0878313	Round	Satin	Medium
VS0878013	Round	Satin	Large
VS0878315	Square	Polished	Medium
VS0878015	Square	Polished	Large
VS0878317	Square	Satin	Medium
VS0878017	Square	Satin	Large

Push plates:

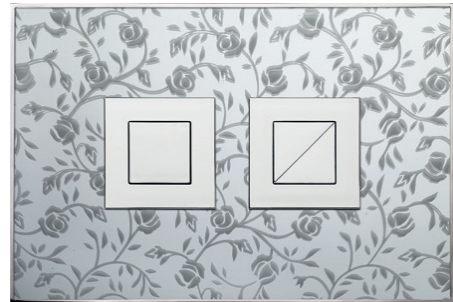
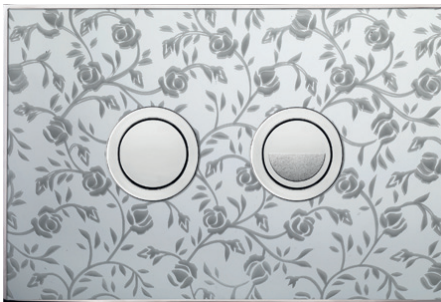

Technical specs:

MEDIUM

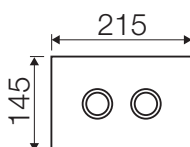

LARGE

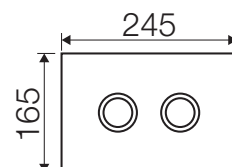

Fantasy Gold glitter

Characteristics

Raw material:	Multilayer glass
Compatible cisterns:	Tropea S, Cubik S, Winner S
Actuator:	Pneumatic

Code	Buttons	Buttons Finishing	Size
VS0878361	Round	Polished	Medium
VS0878061	Round	Polished	Large
VS0878363	Round	Satin	Medium
VS0878063	Round	Satin	Large
VS0878365	Square	Polished	Medium
VS0878065	Square	Polished	Large
VS0878367	Square	Satin	Medium
VS0878067	Square	Satin	Large

Push plates:

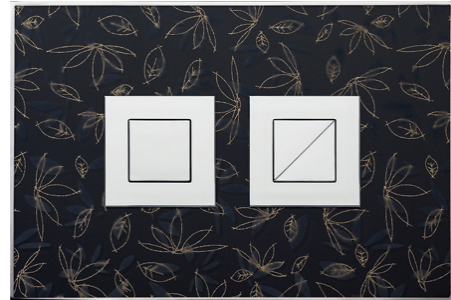

Technical specs:

MEDIUM

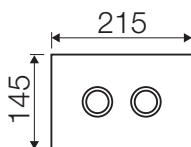

LARGE

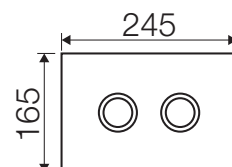

Fantasy Dark geometric

Characteristics

Raw material:	Multilayer glass
Compatible cisterns:	Tropea S, Cubik S, Winner S
Actuator:	Pneumatic

Code	Buttons	Buttons Finishing	Size
VS0878321	Round	Polished	Medium
VS0878021	Round	Polished	Large
VS0878323	Round	Satin	Medium
VS0878023	Round	Satin	Large
VS0878025	Square	Polished	Large
VS0878027	Square	Satin	Large

Push plates:

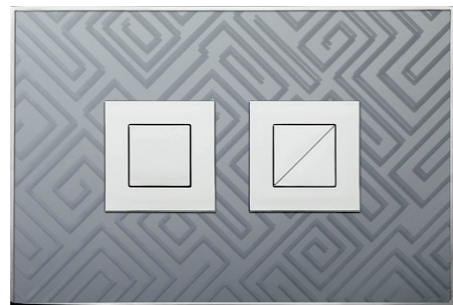

Technical specs:

MEDIUM

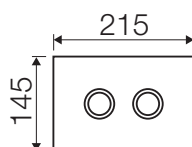

LARGE

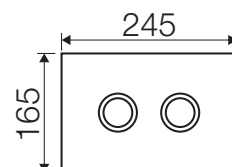

Fantasy Black dichroic

Characteristics

Raw material:	Multilayer glass
Compatible cisterns:	Tropea S, Cubik S, Winner S
Actuator:	Pneumatic

Code	Buttons	Buttons Finishing	Size
VS0878331	Round	Polished	Medium
VS0878333	Round	Satin	Medium
VS0878033	Round	Satin	Large
VS0878335	Square	Polished	Medium
VS0878035	Square	Polished	Large
VS0878337	Square	Satin	Medium
VS0878037	Square	Satin	Large

Push plates:

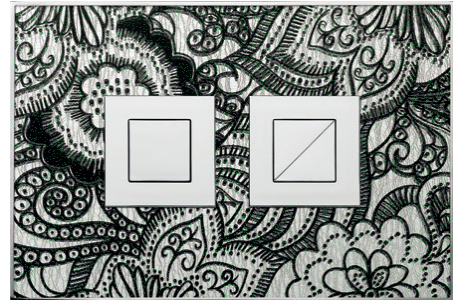
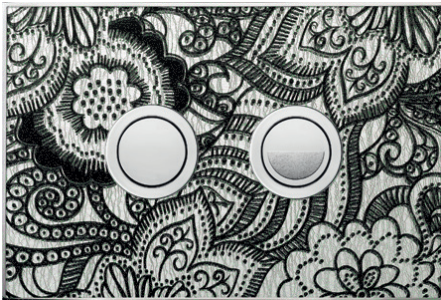

Technical specs:

MEDIUM

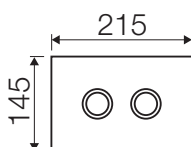

LARGE

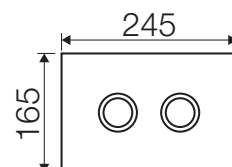

Fantasy Flowers

Characteristics

Raw material:	Multilayer glass
Compatible cisterns:	Tropea S, Cubik S, Winner S
Actuator:	Pneumatic

Code	Buttons	Buttons Finishing	Size
VS0878301	Round	Polished	Medium
VS0878001	Round	Polished	Large
VS0878303	Round	Satin	Medium
VS0878003	Round	Satin	Large
VS0878305	Square	Polished	Medium
VS0878005	Square	Polished	Large
VS0878307	Square	Satin	Medium
VS0878007	Square	Satin	Large

Push plates:

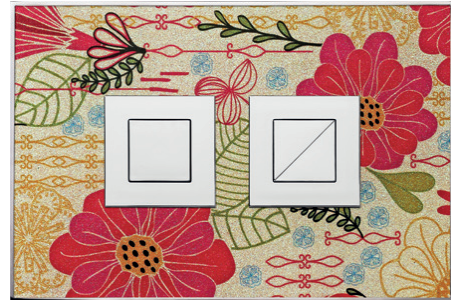

Technical specs:

MEDIUM

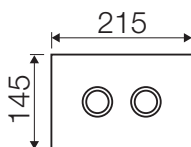

LARGE

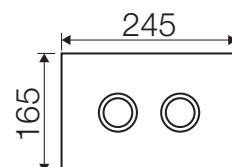

Fantasy Trees

Characteristics

Raw material:	Multilayer glass
Compatible cisterns:	Tropea S, Cubik S, Winner S
Actuator:	Pneumatic

Code	Buttons	Buttons Finishing	Size
VS0878041	Round	Polished	Large
VS0878043	Round	Satin	Large
VS0878345	Square	Polished	Medium
VS0878045	Square	Polished	Large
VS0878347	Square	Satin	Medium
VS0878047	Square	Satin	Large

Push plates:

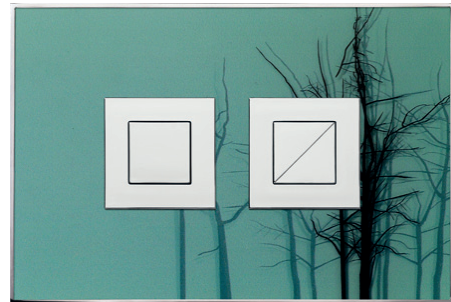

Technical specs:

MEDIUM

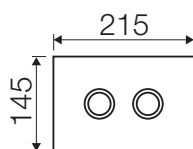

LARGE

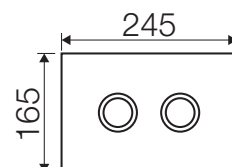

Fantasy Breeze

Characteristics

Raw material:	Multilayer glass
Compatible cisterns:	Tropea S, Cubik S, Winner S
Actuator:	Pneumatic

Code	Buttons	Buttons Finishing	Size
VS0878351	Round	Polished	Medium
VS0878051	Round	Polished	Large
VS0878353	Round	Satin	Medium
VS0878053	Round	Satin	Large
VS0878355	Square	Polished	Medium
VS0878055	Square	Polished	Large
VS0878357	Square	Satin	Medium
VS0878057	Square	Satin	Large

Push plates:

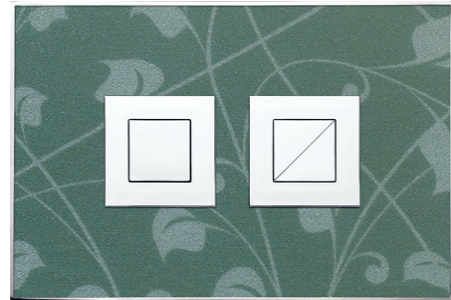
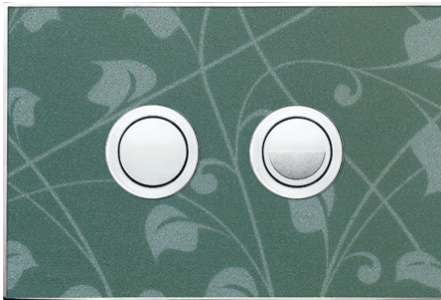

Technical specs:

MEDIUM

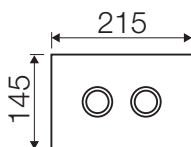

LARGE

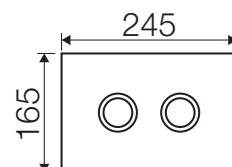

Bespoke kit

Characteristics

Raw material:	Metallic frame
Compatible cisterns:	Tropea S, Cubik S, Winner S
Actuator:	Pneumatic
The inner lining is at the user's choice.	

Code	Buttons	Buttons Finishing	Size
VS0878851	Round	Polished	Medium
VS0878855	Round	Polished	Large
VS0878852	Round	Satin	Medium
VS0878856	Round	Satin	Large
VS0878853	Square	Polished	Medium
VS0878857	Square	Polished	Large
VS0878854	Square	Satin	Medium
VS0878858	Square	Satin	Large

Push plates:

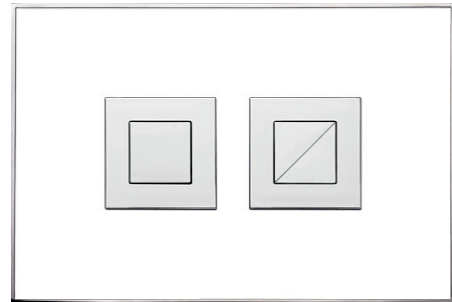

Technical specs:

MEDIUM

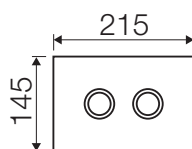

LARGE

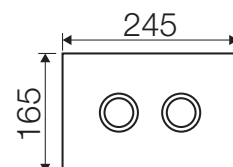

Feel

Characteristics

available for Push plates:	design push plates
Compatible cisterns:	Tropea S, Cubik S, Winner S
Actuator:	Pneumatic

The system allows Valsir Design plates to be installed to the wall.

Code	Thickness	Buttons	Buttons Finishing	Size
VS0879001	5 mm	Round	Polished	Medium
VS0879011	10 mm	Round	Polished	Medium
VS0879003	5 mm	Round	Satin	Medium
VS0879013	10 mm	Round	Satin	Medium
VS0879005	5 mm	Square	Polished	Medium
VS0879015	10 mm	Square	Polished	Medium
VS0879007	5 mm	Square	Satin	Medium
VS0879017	10 mm	Square	Satin	Medium

Push plates:

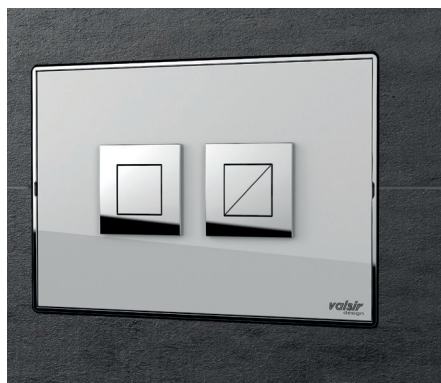

Technical specs:

MEDIUM

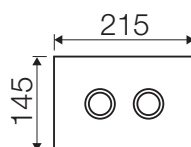

PLUMBING

WASTE SYSTEMS



SUPPLY SYSTEMS



GAS SYSTEMS



FLUSH SYSTEMS



BATHROOM SYSTEMS



TRAPS



RADIANT SYSTEMS



DRAINAGE SYSTEMS



HRV SYSTEM



ACADEMY



SEWER SYSTEMS



WATER TREATMENT



BUILDING

valsir[®]
QUALITY FOR PLUMBING

VALSIR S.p.A.
Località Merlaro, 2
25078 Vestone (BS) - Italy
Tel. +39 0365 877.011
Fax +39 0365 81.268
e-mail: valsir@valsir.it

www.valsir.com

Soggetta all'attività di direzione e coordinamento ex art. 2497 bis C.C. da parte di Silmar Group S.p.A. - Codice Fiscale 02075160172